

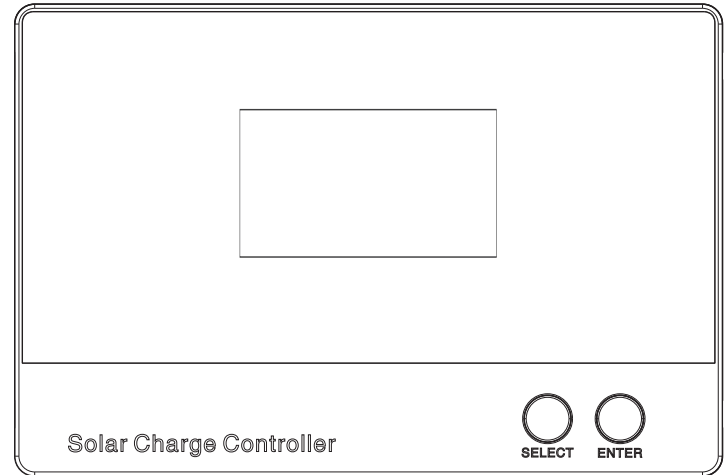







HV2430 User's Manual



Dear users,

Thank you a lot for choosing our product!

Safety Instructions

-  1. In initial installation, please ensure the battery has sufficient voltage so that the controller can be correctly identified as a 12V or 24V system.
-  2. There are no parts required to be maintained or repaired in the controller, please do not disassemble and repair the controller by yourself.
-  3. Since the radiating fin will be very hot during operation, please install the controller in a well-ventilated place.
-  4. Before installing and adjusting the wiring of the controller, be sure to firstly disconnect the wiring of the solar panel and the fuse or circuit breaker near the battery terminals.
-  5. After installation, check whether all lines are tightly connected to avoid the danger of heat accumulation due to loose connections.
-  6. The controller shall be installed near to the battery as far as possible to avoid voltage drop caused by long wire, affecting normal voltage judgment.
-  7. Please follow the safety recommendations of the battery manufacturer.

 **Warning: The operation is dangerous, and safety preparations is required before operation.**

 **Attention: The operation is destructive.**

 **Tips: Suggestions and tips given to the operator.**

Contents

1. Product Introduction	03
1.1 Product features	03
1.2 Appearance and interface description	03
2. Product Dimensions	04
3. Installation Steps	04
4. Menu	05
4.1 Start page	05
4.2 View menu	06
5. Keys	06
6. Parameter Setting	07
6.1 Battery parameter list	07
6.2 Parameter setting list	08
6.3 Battery type (n01)	09
6.4 Equalizing charging\boost charging\floating charging\charging reconnect voltage\over-discharge reconnect voltage\over-discharge voltage (n02-n07)	09
6.5 System voltage (n08)	09
6.6 Full-charging setting (n09)	10
6.7 PWM charging setting (n10)	10
6.8 Light control voltage (n11)	10
6.9 Light control delay (n12)	10
6.10 Load mode (n13)	11
6.11 Load short-circuit protection switch (n14)	11
6.12 Over-discharge delay (n15)	11
6.13 Temperature unit (n16)	12
6.14 TTL communication baud rate (n17)	12
6.15 Device address (n18)	12
6.16 System reboot (n19)	12
6.17 Reset controller (n20)	12
6.18 Clear history (n21)	13
7. Bluetooth Communicator	13
8. TTL communication	13
9. Battery Temperature Sampling and Control	13
10. Application of Battery Voltage Line Loss Compensation	14
11. Common Problems and Solutions	14
12. Error codes	15
13. System Maintenance	15
14. Technical Parameter Table	16

1. Product Introduction

1.1 Product features

- ◆ Products adopt 32-bit high-speed main control chip and large-screen LCD, with adjustable charging and discharging parameters.
- ◆ Support multiple battery types such as sealed battery, gel battery, flooded battery, lithium battery and user-defined battery.
- ◆ The complete multi-stage PWM charging management can be set to off-load charging for better support of voltage-sensitive loads.
- ◆ Dual MOS anti-backflow circuit is equipped with ultra-low heat generation.
- ◆ Lithium battery activation function is provided.
- ◆ Support the full cutoff current setting.
- ◆ Support temperature compensation.
- ◆ Support charging voltage line loss compensation so that the control of battery charging voltage is more accurate.
- ◆ Bluetooth communication is supported, and the product operation status/real-time data and fault status can be viewed through mobile phone APP.
- ◆ Support TTL communication of standard Modbus protocol.
- ◆ Built-in reverse polarity protection, open circuit protection, high temperature protection, overcurrent protection, short circuit protection (available for set), all of which are self-recovery type without damage to the controller.

1.2 Appearance and interface description

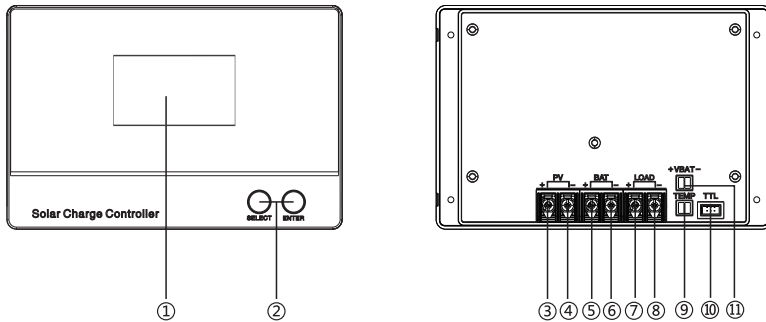

No.	Name	No.	Name
①	LCD (backlit)	⑦	Load positive port
②	Key	⑧	Load negative port
③	Solar panel positive port	⑨	Temperature sensor port
④	Solar panel positive port	⑩	TTL communication port
⑤	Battery positive port	⑪	Battery voltage compensation port
⑥	Battery negative port		

2. Product Dimensions

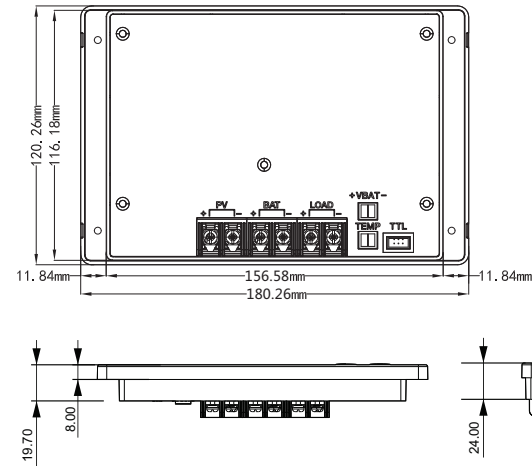

Product model : HV2430

Slot size recommendation : 156.58*116.18*24mm

3. Installation Steps

- 1). The first step is to connect the battery: if the connection is correct, the controller screen will light up, otherwise, please check whether the connection is correct.
- 2). The second step is to connect the solar panel: if there is strong enough sunlight (the voltage of the solar panel is more than the voltage of the battery), the sun icon on the LCD screen will light up, otherwise, please check whether the connection is correct.
- 3). The third step is to connect the load: connect the load cable to the load output terminal of the controller, and the current should not exceed the rated current of the controller.
- 4). Select cables with sufficient capacity to avoid excessive loss on the line and misjudgment by the controller.
- 5). It is important that the battery is fully charged frequently. The battery should be fully charged at least once a month, otherwise it will suffer permanent damage. The battery can only be fully charged when more energy enters the battery than used by the load. Users should keep this in mind when configuring the system.
- 6). Please check whether each wiring terminal of the controller is locked, otherwise the terminal will be easily damaged when the current is excessive.

4. Menu

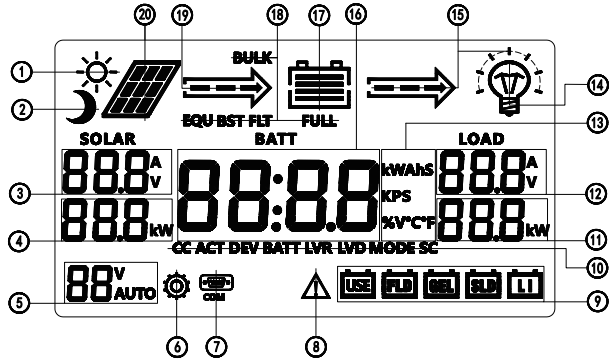

No.	Description	No.	Description
①	Daytime icon	⑪	Load power
②	Night icon	⑫	Load voltage or current
③	Solar panel current or voltage	⑬	Unit symbol
④	Solar panel power	⑭	Load icon
⑤	System voltage	⑮	Load on/of icon
⑥	Parameter setting	⑯	Battery voltage/current, etc.
⑦	Communication icon	⑰	Battery
⑧	System alarms	⑱	Charging stage
⑨	Battery type	⑲	Charging state
⑩	Function character	⑳	Solar panel

4.1 Start page

System power on startup screen is shown as following :

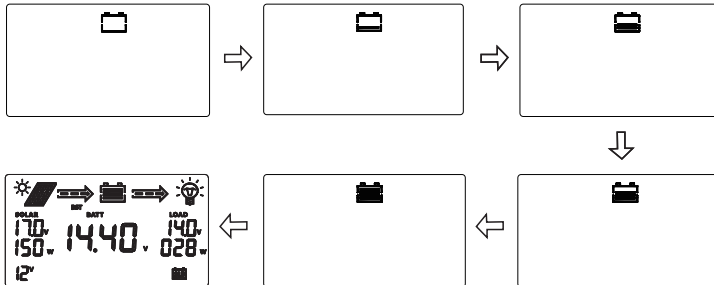

4.2 View menu

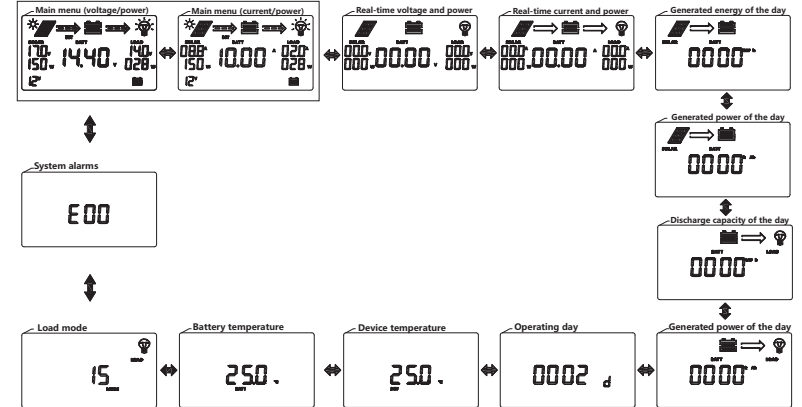

- 1). Alternative display between (voltage/power) and (current/power) on the main menu every 10s.
- 2). Short press [SELECT] to view menu.
- 3). Long press [ENTER] on any interface to enter the parameter setting page.

5. Keys

- ① Key 1-SELECT;
- ② Key 2-ENTER;

Under any key menu, long press the key ENTER to enter the parameter setting menu; short press the key SELECT to switch different setting items; short press the key ENTER to adjust the parameter values; long press the key ENTER to save and exit setting mode.

6. Parameter Settin

6.1 Battery parameter list

Model	HV2430					
Battery type	Sealed Lead-Acid SLD	Colloidal lead acid battery GEL	Front opening lead acid battery FLD	Lithium battery LI	Custom lead acid battery USE	Custom lithium battery USE LI
Setting voltage						
Overvoltage disconnect voltage ^①	16.0V	16.0V	16.0V	16.4V	Boost voltage +2V	Boost voltage +2V
Equalizing voltage ^①	14.6V	--	14.8V	--	9~17V	--
Boost voltage ^①	14.4V	14.2V	14.6V	14.4V	9~17V	9~17V
Floating voltage ^①	13.8V	13.8V	13.8V	--	9~17V	--
Boost restoring voltage ^①	13.2V	13.2V	13.2V	13.2V	9~17V	9~17V
Over-discharge restoring voltage ^①	12.6V	12.6V	12.6V	12.6V	9~17V	9~17V
Under-voltage alarming voltage ^①	12.0V	12.0V	12.0V	12.0V	9~17V	9~17V
Over-discharge voltage ^①	11.1V	11.1V	11.1V	11.1V	9~17V	9~17V
Over-discharge cutoff voltage ^①	10.6V	10.6V	10.6V	10.6V	9~17V	9~17V
Over-discharge delay	5s	5s	5s	5s	5s	5s
Equalizing charging interval	30 days	--	30 days	--	30 days	--
Equalizing charging duration	120 min	--	120 min	--	120 min	--
Boost charging duration	120 min					
Temperature compensation factor mV/°C/2V	-3	-3	-3	--	-3	--

① The above values are the parameters at 25°C/12V; if it is the system of 24V, relevant voltage points shall be automatically multiplied by 2

6.2 Parameter setting list

Setting No.	Function	Setting range	Default
n01	Battery type	FLD/SLD/GEL/LI/USE/USE LI	SLD
n02	Equalizing charging voltage ^①	9V~17V	Available for USE only
n03	Boost charging voltage ^①	9V~17V	Available for USE and USE LI only
n04	Floating charging voltage ^①	9V~17V	Available for USE only
n05	Charging reconnect voltage ^①	9V~17V	Available for USE and USE LI only
n06	Over-discharge reconnect voltage ^①	9V~17V	Available for USE and USE LI only
n07	Over-discharge voltage ^①	9V~17V	Available for USE and USE LI only
n08	System voltage	12/24 /AUTO	AUTO
n09	Charging cutoff current	0-10A (0: turn the function off)	0
n10	PWM charging setting	Pon: PWM charging mode PoF: disconnected charging mode	Pon
n11	Light control voltage ^①	5-11V	5V
n12	Light control delay	60~3600s	60s
n13	Load mode	0-17s	15
n14	Load short-circuit protection	on: Open load short-circuit protection oF: Close load short-circuit protection	on
n15	Over-discharge delay	1-60s	5s
n16	Temperature unit	°C: Celsius/°F: Fahrenheit	°C
n17	TTL communication baud rate	1200~115200kps	9600kps
n18	Device address	1-247	1
n19	System restart	F01	Function key
n20	Factory data reset	F02	Function key
n21	Clear historical data	F03	Function key

6.3 Battery type (n01)

Please refer to "6.1 and 6.2" for setting.

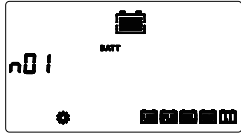

6.4 Equalizing charging\boost charging\floating charging\charging reconnect voltage\over-discharge reconnect voltage\over-discharge voltage (n02-n07)

- Icon not displayed: It indicates that the current parameters can't be set, and only for view.
- Icon displayed: It indicates the current parameters can be edited.

Equalizing charging voltage

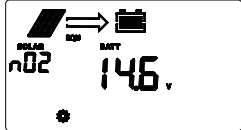

Boost charging voltage



Floating charging voltage

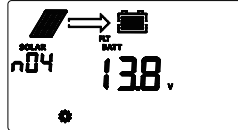

Over-discharge voltage

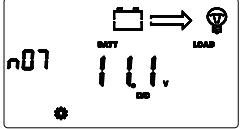

Over-discharge reconnect voltage



Boost charging reconnect voltage



6.5 System voltage (n08)

When the system voltage changes, the system voltage icon on the main page will flash, prompting the user to reboot for effective operation.

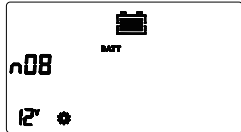

6.6 Full-charging setting (n09)

- 1).[oF]: Set 0
- 2).[on]: Select the appropriate current value between 1-10A

Full-charging condition: When the constant voltage charging duration of lithium battery reaches the set duration or after the lead-acid battery is transmitted into float charging, and the charging current is less than the set current value, the system will stop charging after 1 minute, and the "FULL" icon will light up on the screen;

Charging recovery condition: The battery voltage is less than the boost charging reconnect voltage, the system will recover charging, and the "FULL" icon will light off on the screen.

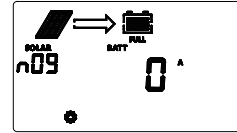

6.7 PWM charging setting (n10)

PWM charging mode

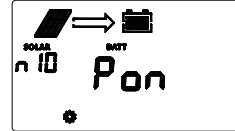

PWM charging mode

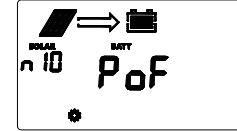

Pon refers to PWM charging mode;

PoF refers to disconnected charging mode, charging will be stopped when the battery voltage is more than the boost charging voltage; the charging will be restored when the battery voltage is less than the reconnect voltage of the boost charging.

Note: PWM charging setting (only work for Li and USE Li). For voltage sensitive loads, it is recommended to use disconnected charging mode.

6.8 Light control voltage (n11)

- 1).[Light control on]: The solar panel voltage is less than $5V \times N$
- 2).[Light control oF]: The solar panel voltage is greater than $6V \times N$ (N is 1 for 12V system; N is 2 for 24V system)

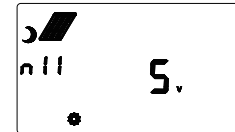

6.9 Light control delay (n12)

Minimum duration required to meet the light control on or off condition.

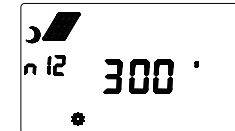

6.10 Load mode (n13)

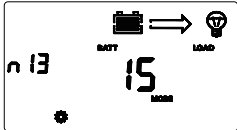

LCD screen number	Load mode	Description
0	Pure light control	When the solar panel voltage is less than the Light control ON voltage with a duration is more than the light control delay, turn on the load; When the solar panel voltage is greater than the light control OFF voltage with a duration is greater than the light control delay, turn off the load.
1~14	Light control+time control 1-14h	When the solar panel voltage is less than the Light control ON voltage with a duration is more than the light control delay, turn on the load. When the working time of the load achieves the setting time, the load is turned off. After the duration during which the solar panel voltage is greater than the light control OFF voltage is greater than the light control delay, turn off the load (light control prevails).
15	Manual mode (default)	Short press [ENTER] key to turn on/off the load (not affected by light control)
16	Debugging mode	When the solar panel voltage is less than the light control ON voltage, turn on the load immediately. When the solar panel voltage is greater than the light control OFF voltage, turn off the load immediately
17	Normal on mode	The load is always on (In case of battery over-voltage, battery over-discharge, load short-circuit, overload, battery over-temperature, or device over-temperature, the load will turn off the output)

6.11 Load short-circuit protection switch (n14)

Some inductive loads or capacitive loads will produce high current at the moment of start-up, which will easily trigger load short-circuit protection, resulting in failure to turn on the load. This function can be disabled when the system cannot be started (Note: After this function is disabled, short circuit at load side of the controller is prohibited!)



Turn on load short-circuit protection Turn off load short-circuit protection

6.12 Over-discharge delay (n15)

After the battery voltage is lower than the over-discharge voltage, the controller turns off the delay time for the load.

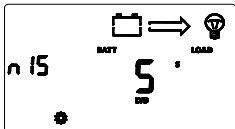

6.13 Temperature unit (n16)

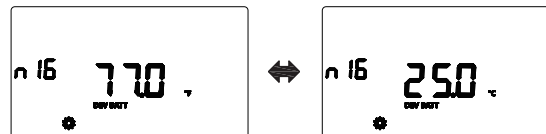

The unit is Fahrenheit '°F'

The unit is centigrade '°C'

6.14 TTL communication baud rate (n17)

The TTL communication baud rate can be modified according to actual needs.



6.15 Device address (n18)

The device communication address can be modified according to actual needs.



6.16 System reboot (n19)

Single press [ENTER], 'F01' flashes; single press [ENTER] again, the controller will reboot.



6.17 Reset controller (n20)

Reset the controller to factory default parameters in accordance with "6.16".

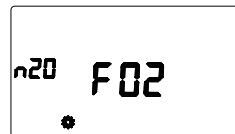

6.18 Clear history (n21)

Clear the historical data of the controller in accordance with "6.16".

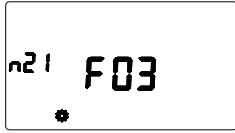

7. TTL communication

Built-in Bluetooth communication function can monitor the running data, fault status and adjust the running parameters of the controller in real time through the mobile APP.

8. TTL communication

- 1). Default baud rate: 9,600 bps, check bit: none, data bit: 8 bit, stop bit: 1 bit
- 2). Communication power supply output specification: (12V±3V)/100mA

	No.	Definition
①	①	VCC communication power supply output
②	②	RX controller data receiving end
③	③	RX controller data receiving end
④	④	GND

9. Battery Temperature Sampling and Control

- 1). As shown in port [7] below, connect the temperature sensor to the corresponding temperature interface to achieve the high and low temperature protection for the battery and the temperature compensation for the charging voltage of lead-acid battery (no temperature compensation for the lithium battery); if the temperature sensor is not connected, the default temperature is 25°C;
- 2). For the battery-related temperature protection/recovery value, please refer to the description in "11. System Alarms".

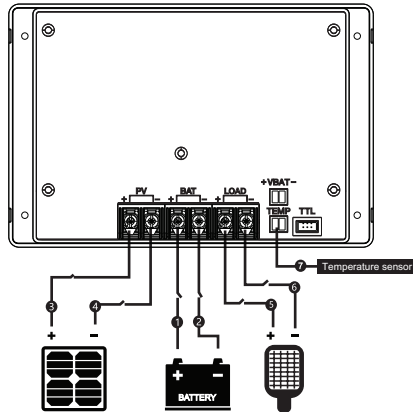

10. Application of Battery Voltage Line Loss Compensation

- 1). Since the line diameter from the battery to the controller is too small, when the charging power is large, the voltage collected by the controller terminal will be higher than the actual voltage of the battery terminal, resulting in the battery being not fully charged; connecting the voltage compensation line can more accurately collect the battery terminal voltage, and timely output the voltage difference compensation, so that the battery terminal can get a more proper charging voltage.
- 2). Positive/negative electrodes of the battery are connected to the positive and negative electrodes of the battery voltage sampling port [8] with the compensating wire, as shown in the diagram:

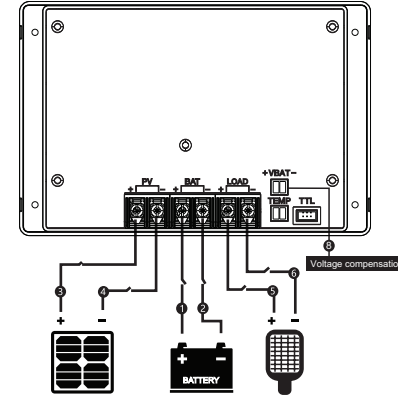

11. Common Problems and Solutions

Phenomenon	Troubleshooting
LCD screen does not light up	Check whether the battery and solar panel are properly connected and whether the LCD connection cable has a poor connection
There is voltage in the solar panel, there is no voltage output from the battery side, and code E1 is displayed	If the system is not set with lithium battery, when the battery is not connected, there is no voltage output from the two ends of the battery; when the battery is connected, the voltage output will return to normal
12V or 24V normal voltage battery is connected, the battery icon on the LCD screen flashes slowly, and code E1 is displayed	Check the battery system voltage, or set it to automatically identify and reboot the controller
The system voltage 12/24 icon on the screen flashes	Set system voltage change, prompting the user to reboot the system for the change to take effect
The controller fails to charge	Check the wire for wrongly connected, the solar panel for overpressure, reverse connection and overcurrent, the battery for overpressure and over-temperature, the lead-acid battery for open circuit, and the device for over-temperature. Check the error code on LCD screen.
Fail to start some loads	Try enabling the load short-circuit function after checking that the wiring is correct
The screen displays "full", and charging stops	Charging stops as the charging cut-off current conditions are met. When the voltage is below the boost charging reconnect voltage, the charging will be automatically resumed
System alarm code	See Table "11. System Alarms" for details
Other problems or exceptions difficult to resolve	Try F01 reset Reset controller (F02), and reset relevant parameters again as per system configurations. Be careful!

12. Error codes

Error codes	Meaning	Description
E0	Normal system	No action
E1	Battery over-discharge	When the battery voltage is less than the setting value, the load is turned off; when the battery voltage rises to the over-discharge return voltage, release over-discharge, the load output is recovered.
E2	Battery over-voltage	When the battery voltage is greater than the setting value, charging and the load are turned off; check the reason why the battery is over voltage; it will automatically recover when the battery voltage decreases.
E4	Load short-circuit	The load short-circuit can be timely protected and automatically recovered after 10 s; the number of short-circuit is 5 times at most for one day; the load short-circuit can be manually removed if it occurs.
E5	Load overload	The load current is greater than setting value (when the current exceeds 32 A, the load will be turned off in time delay; when the load exceeds 35A, the load will be turned off immediately), and it will recover after 10 s. The load overload can be manually removed in case of load overcurrent.
E6	Device over-temperature protection	When the internal controller temperature is greater than the setting value 70°C, the load and charging are turned off; when the temperature is decreased to 60°C for 2 seconds, charging and load output will automatically recover.
E7	Battery over-temperature protection	Battery over-temperature protection is required to connect battery temperature sampling sensor; when the sensor measures the battery temperature is more than 75°C, the load and charging is turned off; when the temperature is decreased to 65°C for 2s, charging will automatically recover.
E8	Charging overcurrent	When the solar panel current exceeds the setting value, the charging is turned off after a delay or the charging protection is turned off immediately, and it will recover automatically after 10s.
E10	Solar panel overvoltage	When the solar panel voltage exceeds the setting value 55V, the charging is turned off; when the solar panel voltage is reduced to 50V, the charging will recover automatically.
E13	Reverse connection of solar panel	When the solar panel polarity is reversed, the charging is turned off; the charging will recovered after the wrong wiring is corrected.
E15	Abnormal lead-acid battery	In lead-acid battery mode, the battery is damaged or not connected.

13. System Maintenance

In order to maintain the optimal operating performance of the controller for a long time, it is recommended that the following items are regularly checked.

- ◆ Make sure that the airflow around the controller is not blocked, and remove any dirt or debris from the radiator.
- ◆ Take corrective actions timely after any fault or error is found.
- ◆ Check whether there is corrosion, insulation damage, high temperature or burning/discoloring at terminals, case distortion, etc., and repair or replace timely if any.
- ◆ Check whether there is any exposed or broken wire or wire with poor insulation, and repair or replace timely if any.
- ◆ Check whether there is dirt, nesting insects or corrosion, and clean timely if any.

Warning: There is a risk of electrical shock! Before carrying out checks or operations above, make sure that all power supplies for the controller are disconnected! Any non-professional personnel is prohibited from carrying out such operations.

14. Technical Parameter Table

Parameter	Parameter value
Product model	HV2430
No-load loss	< 7mA/12V ; < 10mA/24V
Battery type	USE/FLD/GEL/LI/SLD (default)
System voltage	12V/24V/AUTO(default)
Battery operating voltage range	9V~32V
Rated charging current	30A
Maximum solar panel power	400W/12V ; 800W/24V
Maximum PV open-circuit voltage	55V
Rated load current	30A
Load operating mode	Light control, light control, time control, manual mode (default), debugging mode, normally open
Line loss compensation	Support
Charging cutoff current setting	Support
Charging temperature compensation of lead-acid battery	Support
Temperature protection	Support
Overload/Short-circuit protection	Support
Bluetooth communication	Support
TTL communication	Baud rate 9,600kps (adjustable range 1,200 kps~115,200kps)
Backlit function	Light up when there is keys operation and automatically light off after 20s without keys operation
Protection function	PV overvoltage protection, PV reverse polarity protection, charging overcurrent protection, night reverse charging protection, over-temperature protection, load short-circuit protection, load overload protection, battery overvoltage/over-discharging protection.
Operating ambient temperature range	-35°C~65°C
Protection grade	IP32
Cooling mode	Natural heat dissipation
Dimension	180.26*120.26*19.7mm
Weight	362g